

MANUAL MB-008

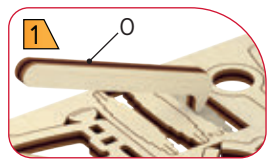

This tool is for pushing the small pieces out of the board. Also may be used for disassembly.

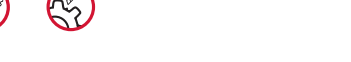
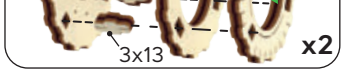
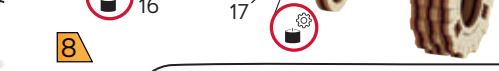
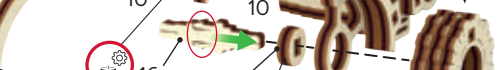
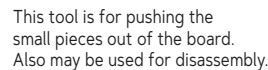
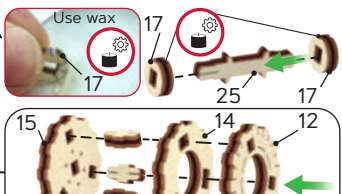
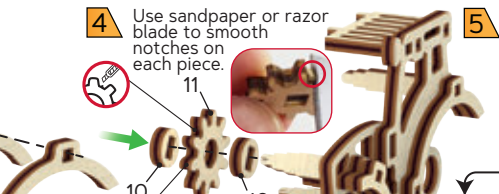
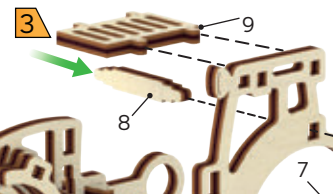
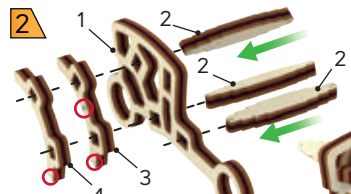
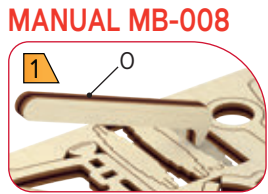
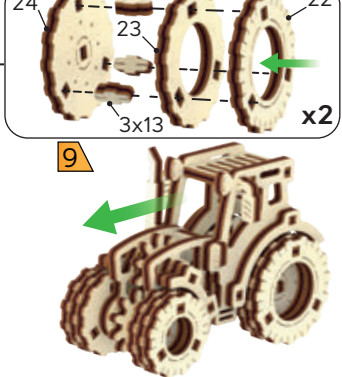
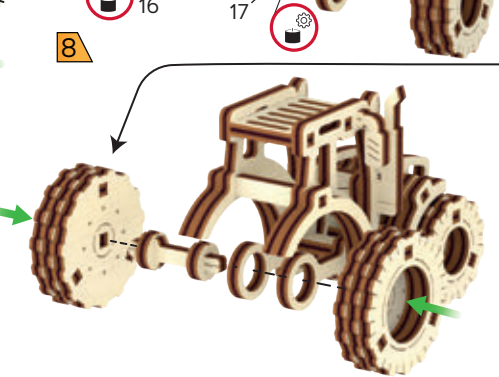
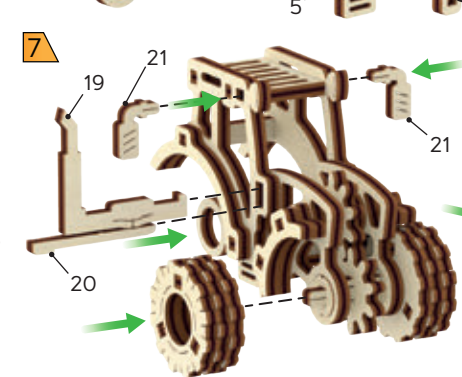
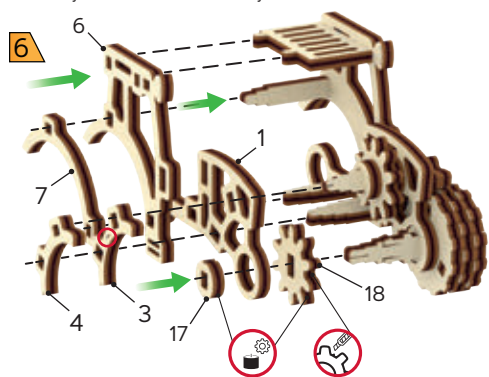

4 Use sandpaper or razor blade to smooth notches on each piece.

5 Use wax

